

# Technical Overview

## S3 Digital Cutter



Your first choice in digital cutting.

# S3 Cutter

## Intelligent, efficient, flexible

### Modular tooling

Define the functions your S3 cutters needs to perform, and select the Zünd tools that will make up the perfect configuration for you.

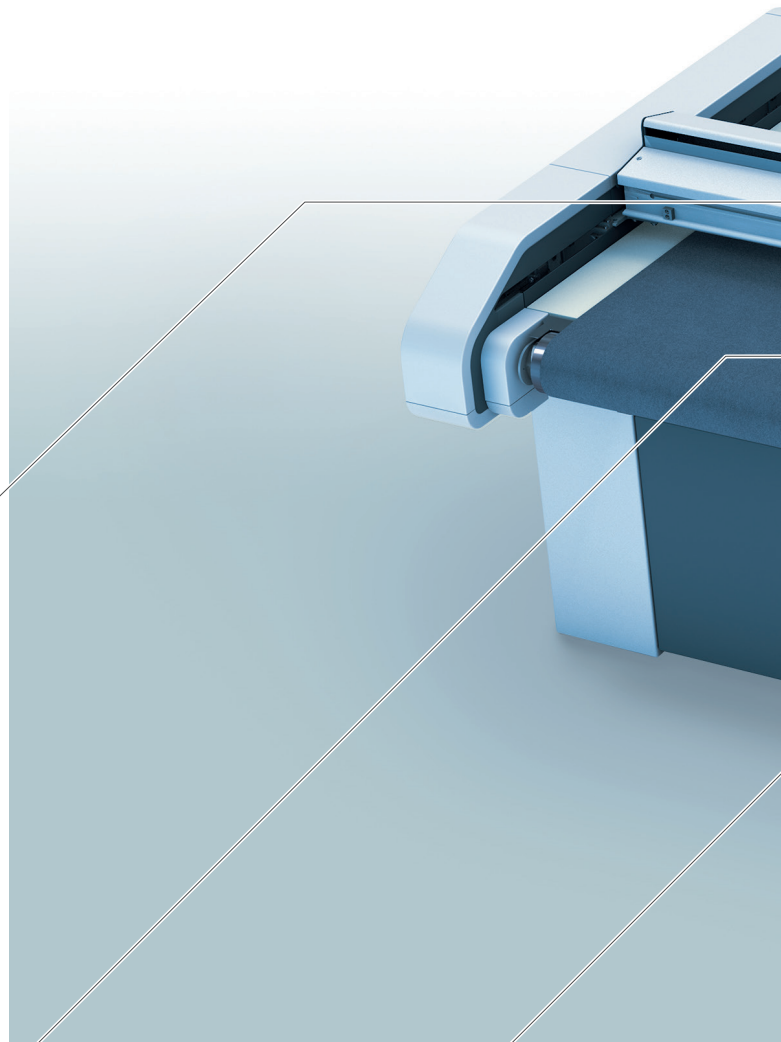

### Cutting surface and material hold-down

The S3 features an acrylic vacuum plate. The vacuum holds down the material and is steplessly adjustable across the width of the machine. An energy-efficient vacuum generator provides optimal hold-down.

### Automatic tool initialization

An automated initialization system is used for tool setup. It helps the cutter determine the proper cutting depth quickly, precisely and efficiently.

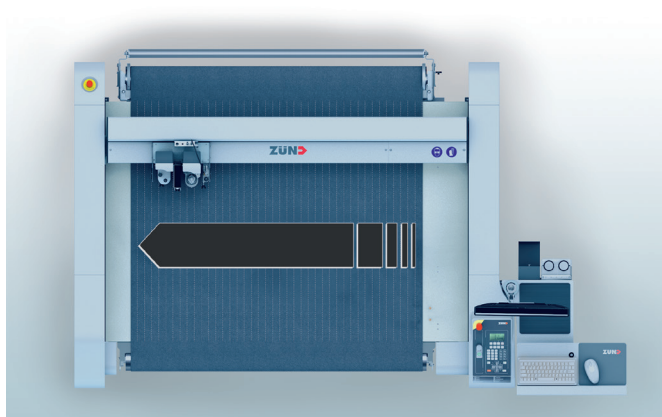

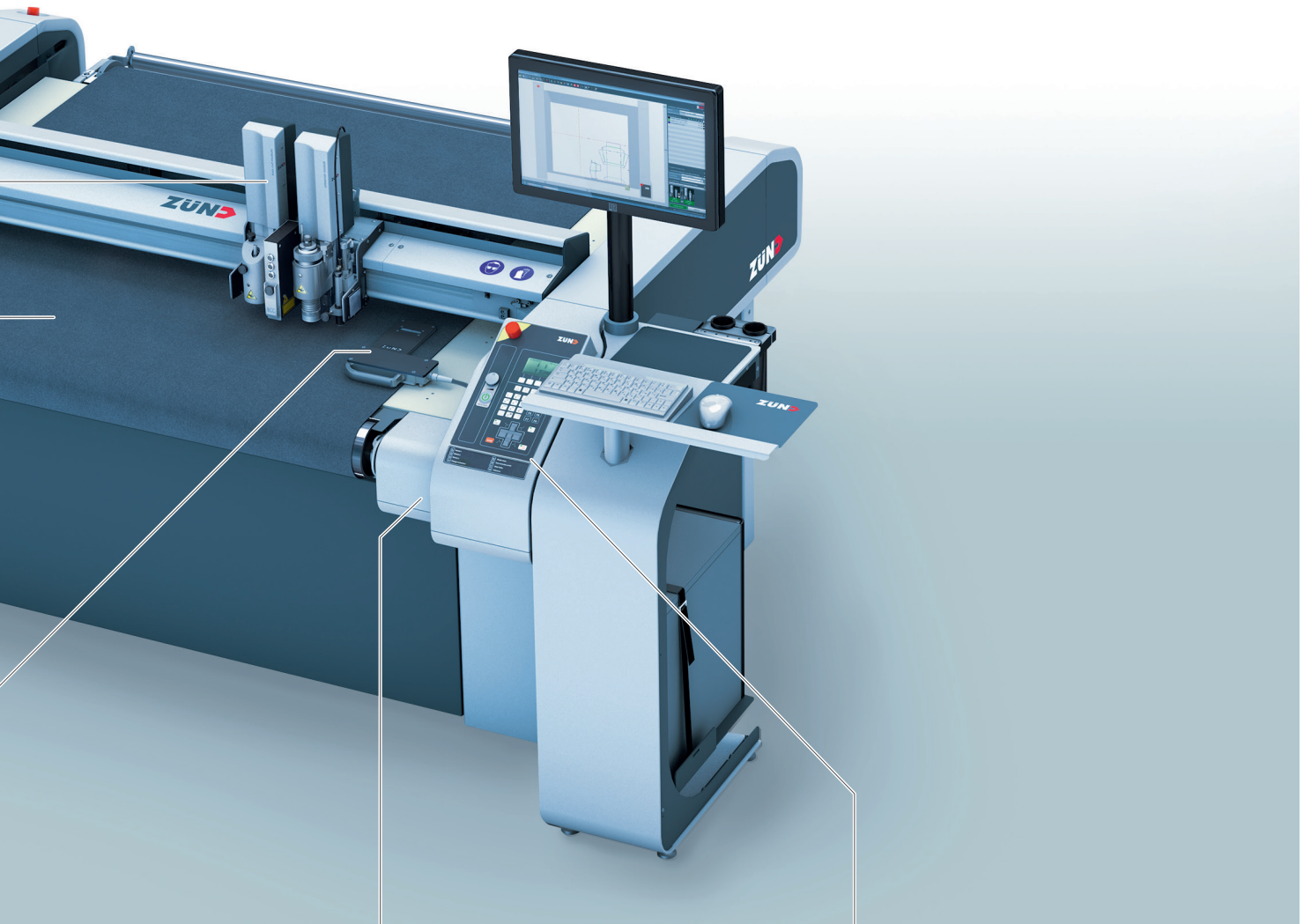

### Intelligent performance

The intelligent control technology behind the S3 is particularly impressive. It delivers exceptional performance by combining carefully optimized cutting technology with a precise, maintenance-free drive system.

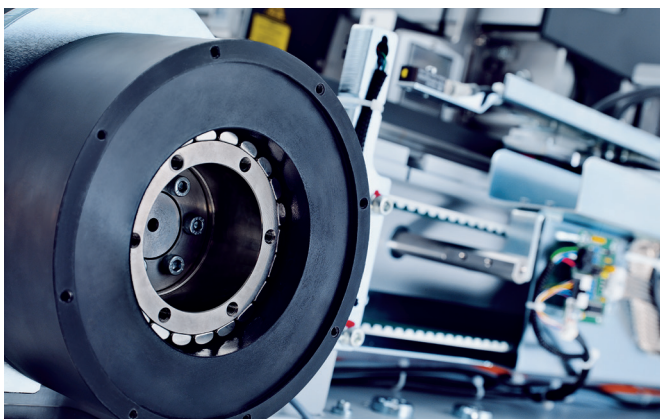

### Ergonomics and operation

The construction and design of the S3 is tailored to the needs of our customers. Ergonomic, user-friendly operation and simple handling are the result.



# The Zünd building-block design

## Investing in the future

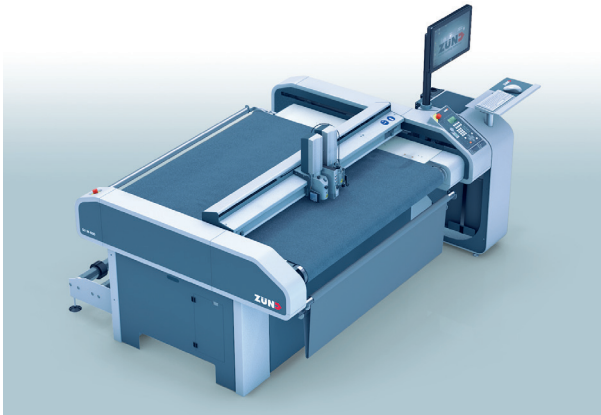

### Technology with a purpose

The base machines are the core of the Zünd modular design concept. In keeping with this building-block system, every tool and option is designed to be easily and cost-effectively added or upgraded any time. From the earliest stages of development, new innovations are continually integrated according to the same modular concept. No matter how you decide to configure your Zünd cutting system today, you are making a safe investment for tomorrow.

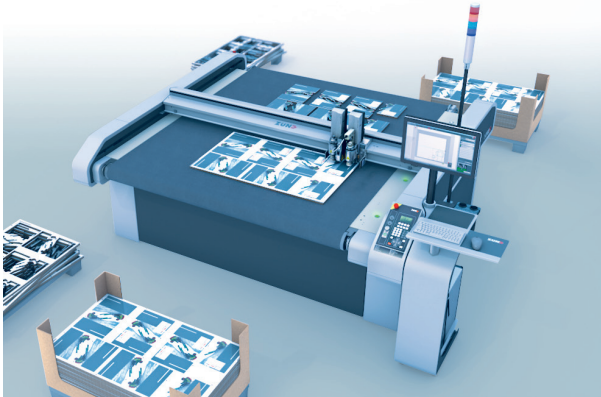

### Tandem operation

In this type of tandem or "pendulum" production, loading/unloading and production occur at the same time. While the operator loads material on one side, the cutter continues processing on the other. This setup increases workflow efficiency, keeps idle time to a minimum and maximizes productivity.

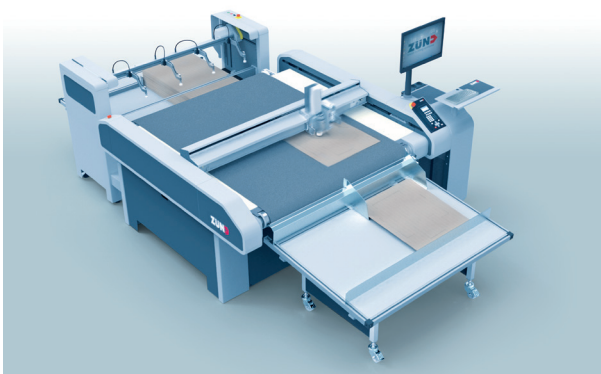

### Fully automated sheet/board handling

With the sheet feeder, you can turn your S3 cutter into a fully automated production system. Sheets of vinyl and denser cardboard materials are picked up with vacuum grippers and transferred from the loading table to the cutting surface. After processing, the machine advances the cut materials and waste onto an off-load table. Especially for large jobs, this fully automated workflow gives you the necessary tools for reliable, efficient production.

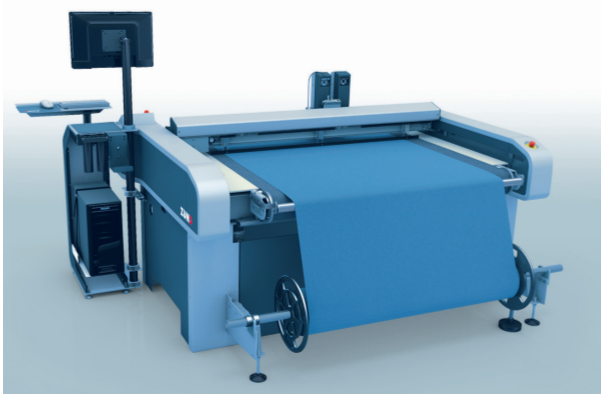

### Roll-off units

Zünd offers a variety of roll-off systems for different types of materials. Each type of roll-off is designed and optimized for specific material characteristics. For textile applications, for example, we recommend a shafted roll-off system. In combination with the guide roll, even delicate materials such as silk can be advanced without wrinkles or stretch.

# Solid reasons for Zünd S3



## Zünd

Zünd Systemtechnik AG - family-owned and based in Switzerland - specializes in digital cutting systems. The Zünd name represents Swiss quality and has become synonymous with precision, performance and reliability.

Since 1984 we have been designing, producing and marketing modular cutting systems and have gained a global reputation as market leader. The technological superiority of our products stems from our insistence on high quality standards, modular design and focus on our customers.



## Modularity

Zünd cutting systems are based on a design concept that lends them greater flexibility and adaptability than any others on the market can offer. This unique modularity makes it possible to cost-effectively configure and upgrade Zünd cutters for ever-changing cutting needs. This contributes to their exceptional ROI and makes them retain their value over many years.



## Profitability

Solid performance, outstanding quality - thousands of Zünd cutting systems worldwide are producing non-stop and offer daily proof of their unparalleled profitability.

Innovative technology and superior standards of construction guarantee low maintenance costs. Outstanding energy efficiency is yet another benefit of our products. Optimal processing methods, state-of-the-art vacuum generators and sophisticated material-advance systems keep energy demands low and contribute to the eco-friendliness and sustainability of our products.



## Worldwide service

What applies to our cutting systems, also applies to our service: Exceptional performance, precision and reliability. Optimally trained and highly experienced specialists are always at your disposal.

Zünd technicians all over the world are only a phone call away. Our subsidiaries and distribution partners in your vicinity strive to keep response times to a minimum and are ready to provide support whenever the need arises.

# S3 digital cutting systems

## Choice of sizes



**S3 M-800**  
1330 x 830 mm



**S3 M-1200**  
1330 x 1230 mm



**S3 L-1200**  
1800 x 1230 mm

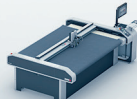

**S3 XL-1200**  
2270 x 1230 mm

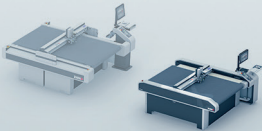

**G3/S3 M-1600**  
1330 x 1600/1630 mm

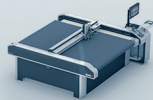

**S3 L-1600**  
1800 x 1630 mm

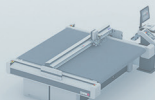

**G3 XL-1600**  
2270 x 1600 mm

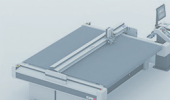

**G3 2XL-1600**  
2740 x 1600 mm

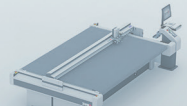

**G3 3XL-1600**  
3210 x 1600 mm

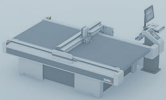

**G3 M-2500**  
1330 x 2500 mm

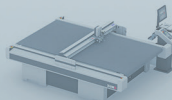

**G3 L-2500**  
1800 x 2500 mm

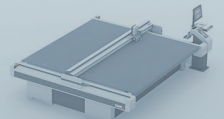

**G3 3XL-2500**  
3210 x 2500 mm

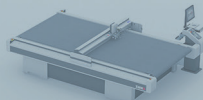

**G3 L-3200**  
1800 x 3200 mm

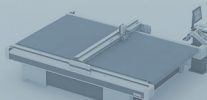

**G3 XL-3200**  
2270 x 3200 mm

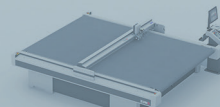

**G3 2XL-3200**  
2740 x 3200 mm

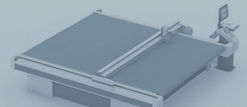

**G3 3XL-3200**  
3210 x 3200 mm

**Zund UK Ltd.**  
Unit 1 Spring Valley Business Centre  
Porters Wood, St. Albans AL3 6PD  
United Kingdom  
T +44 1727 833 003  
F +44 1727 833 006  
salesuk@zund.com  
www.zund.com

**Zünd Systemtechnik AG**  
Industriestrasse 8  
CH-9450 Altstätten  
T +41 71 554 81 00  
info@zund.com  
www.zund.com